

ISTRUZIONI D'APERTURA / DIRECTIONS TO OPEN /
ANWEISUNGEN FÜR DIE ÖFFNUNG / MODE D'EMPLOI
POUR OUVRIR

D_01

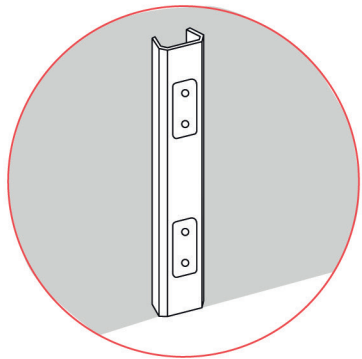

D_02

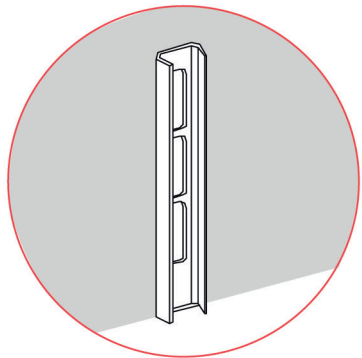

STEP 1

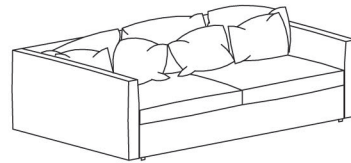

STEP 2

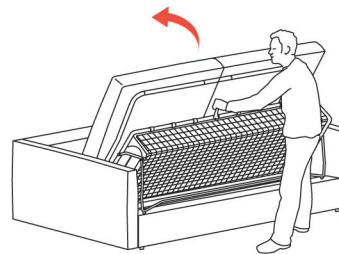

STEP 3

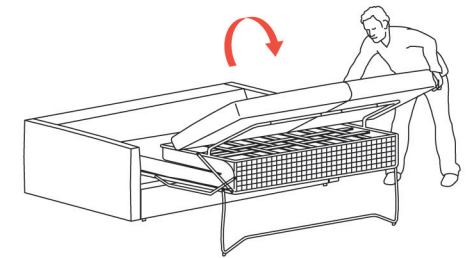

STEP 4

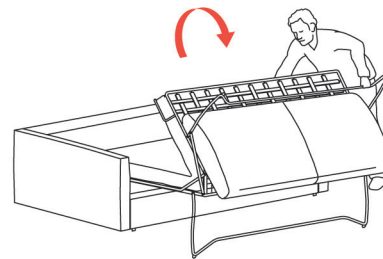

STEP 5

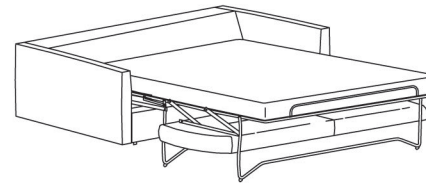

ISTRUZIONI DI MONTAGGIO / INSTRUCTIONS
FOR ASSEMBLING / MONTAGENLEITUNGEN /
MODE D'ASSEMBLAGE

**ATTENZIONE / CAUTION / ACHTUNG /
ATTENTION**

Non sollevare mai il divano completo di braccioli /
Never lift the sofa with assembled arms /
Nie das Sofa mit bzw. bei den Armlehnen anheben /
Ne jamais soulever le canapé par les accoudoirs

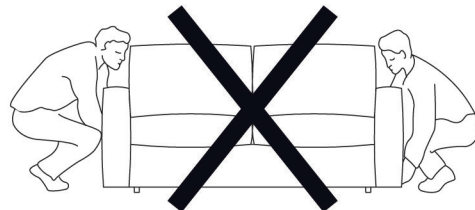

**AVVERTENZE / NOTICE / HINWEISE /
INDICATION**

Prima di aprire il letto rimuovere i fili di metallo posti sul
meccanismo /
Remove the metal wires from the mechanism before
opening the bed /
Vor dem Öffnen des Bettsofas entfernen Sie bitte die
Metalldrähte vom Mechanismus /
Avant d'ouvrir le lit, ôter les fils en métal posés sur le
mécanisme

